



WAS ZÄHLT IST WAS DAHINTER STECKT.

MARMOX niches



CMB
GROUP

MEMBER OF CMB GROUP

MARMOX BOARD

MARMOX niches

MARMOX niches is a prefabricated wall unit to create shelves in bathrooms or wet rooms. Installation in the wall of shower areas. They are ideally suited to provide a shelf for shampoo or showergel or even just be used for decoration purposes in the bathroom.

Produced from MARMOX BOARD building boards with a waterproof core of XPS foam and a sealing of the joints, a fast and accurate installation is possible without complex construction. With MARMOX niches inexpensive spacious or smaller shelves in the shower or bath area which can be flooded individually and thus accentuate the design of the bathroom.

Suitable for private and commercial use.

Installation

MARMOX niches are suitable for installation in solid walls as well as suitable for stud walls. In all cases, the flange must be firmly bonded all around it with a load-bearing substrate is necessary. For this purpose, a studded wall may need to be used. If necessary, beams have to be installed.

Thanks to the factory-mounted sealing fleece, which overlaps by approx. 10 cm, it guarantees a secure seal of the surrounding joints.



MARMOX niches with waterproofing fleece

Dimensions

Available in the following dimensions:

Product	Thickness flange (G)	Outer dimension with flange mm (AxBxC)	Inner dimension shelf mm (DxExF)
Niche 40/20	12,5 mm	500 x 300 x 100 mm	400 x 200 x 87 mm
Niche 40/30	12,5 mm	500 x 400 x 100 mm	400 x 300 x 87 mm
Niche 40/40	12,5 mm	500 x 500 x 100 mm	400 x 400 x 87 mm
Niche 40/50 (with shelf 500 x 87 x 30 mm)	12,5 mm	500 x 600 x 100 mm	400 x 500 x 87 mm

Other individual dimensions available on request.

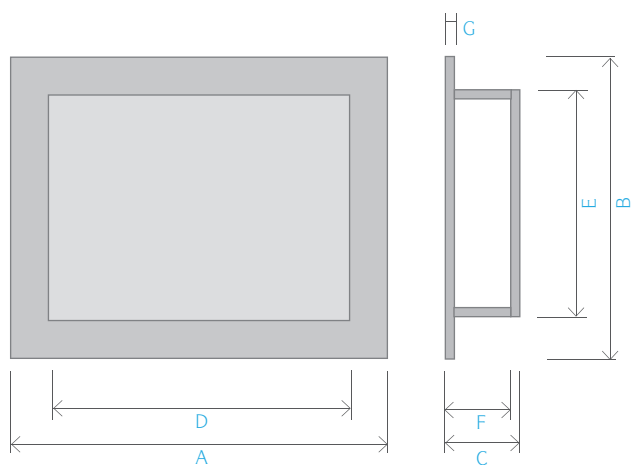

Dimensions MARMOX niches

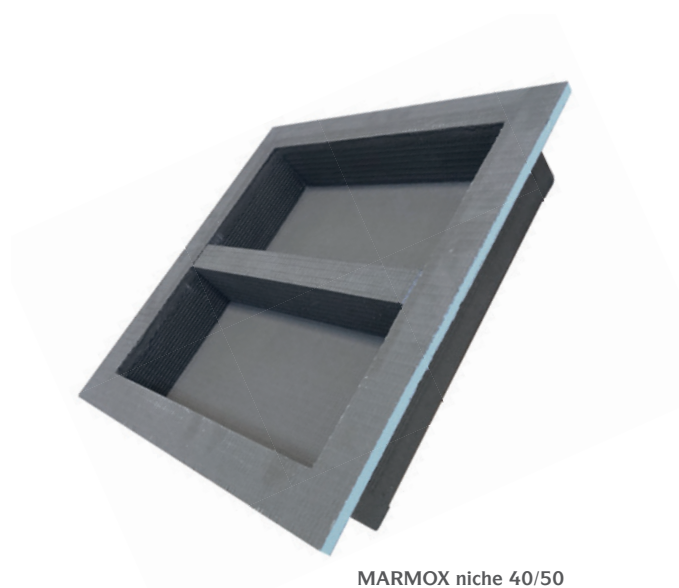

MARMOX niche 40/50
with shelf

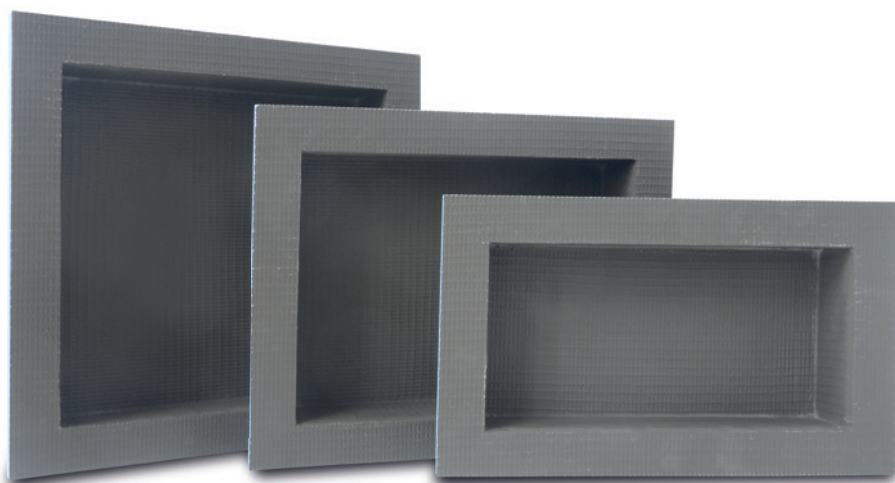

MARMOX niches

Installation in solid walls

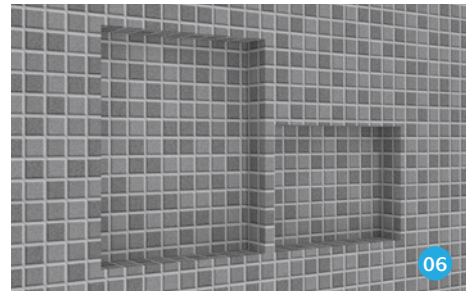
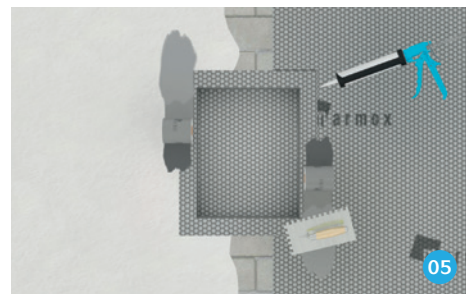
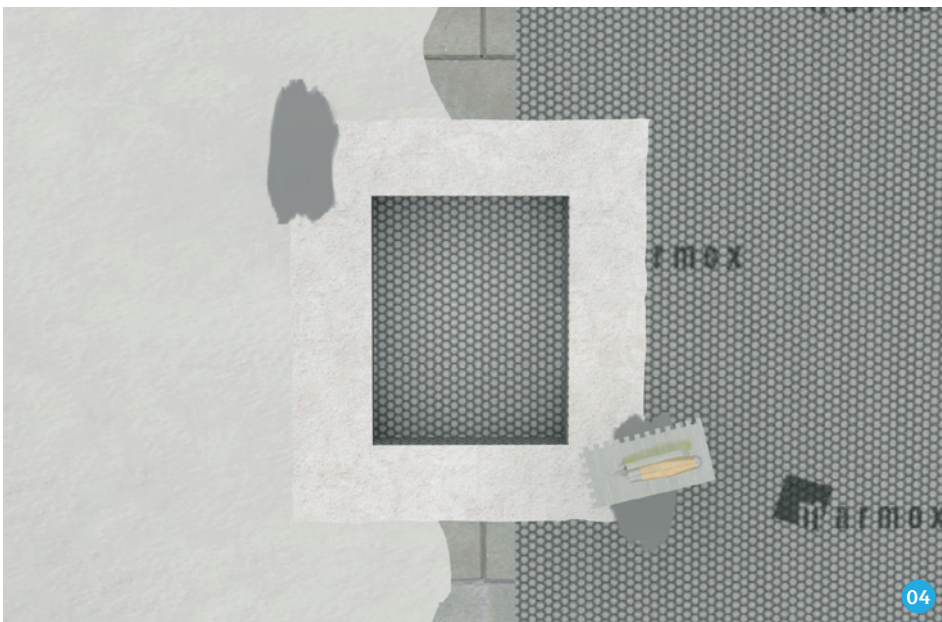
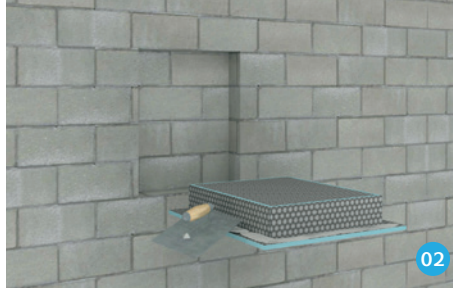

Work steps:

- 01** Exposing the installation space for the niche in the wall.
- 02** Apply the glue to the flange, if necessary fill the void between niche and the empty space in the wall and insert niche. Please make sure that the thickness of the flange corresponds to the thickness of the plaster or building panels.
- 03** Inserting and aligning the niche.
- 04** For niches with fleece:
All-round embedding of the fleece with sealing slurry.
- 05** For niches without fleece:
Gluing the joints and embedding of the waterproofing fleece with waterproofing slurry.
- 06** Tiling.

Vertical installation of narrow niches (20/40 and 30/40) in stud walls

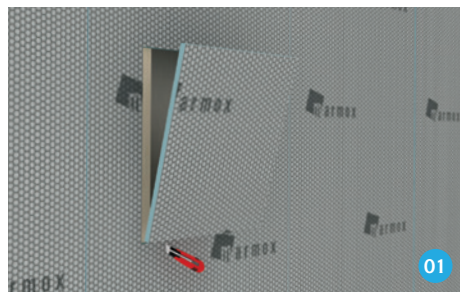

01

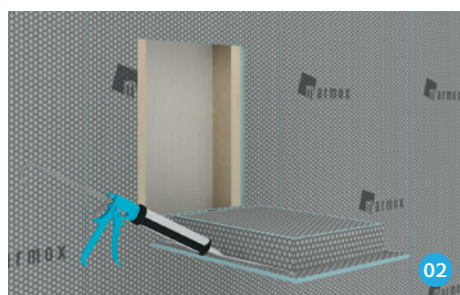

02

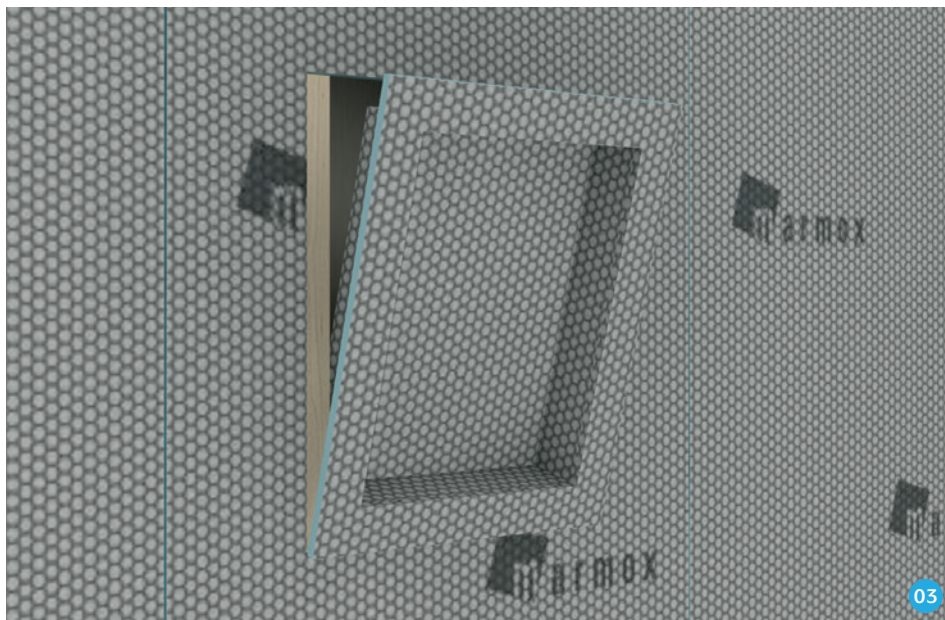

03

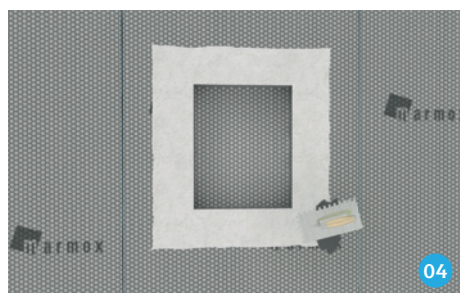

04

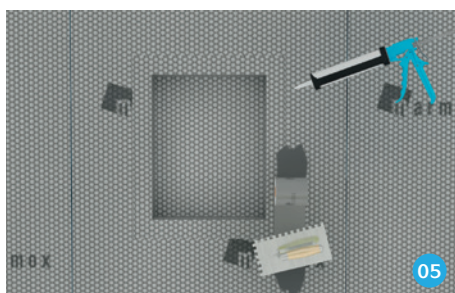

05



06

Work steps:

- 01 Cutting out the building board in the designated area. Make sure that the stud frame partly for the gluing of the niche is free.
- 02 Apply adhesive.
- 03 Fitting and fixing.
- 04 For niches with fleece: All-round embedding of the fleece with sealing slurry.
- 05 For niches without fleece: Gluing the joints and embedding of the waterproofing fleece with waterproofing slurry.
- 06 Tiling.

Horizontal installation of wide niches (40/40 and 40/50) in stud walls

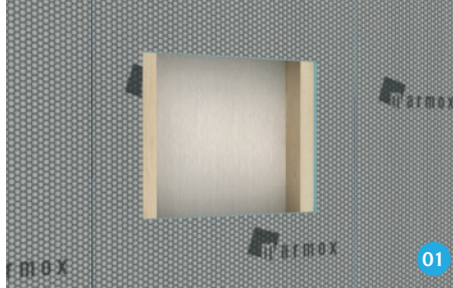
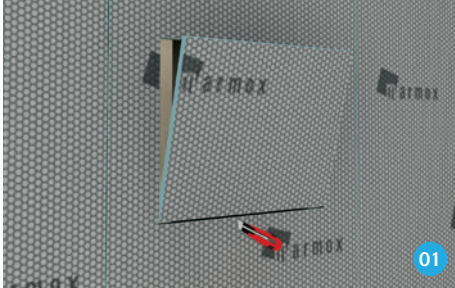

02 Wooden stud frame

03 Wooden stud frame

04 Metall stud frame

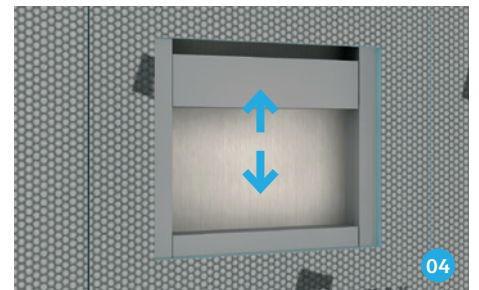
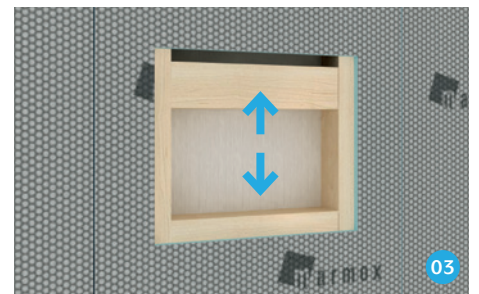
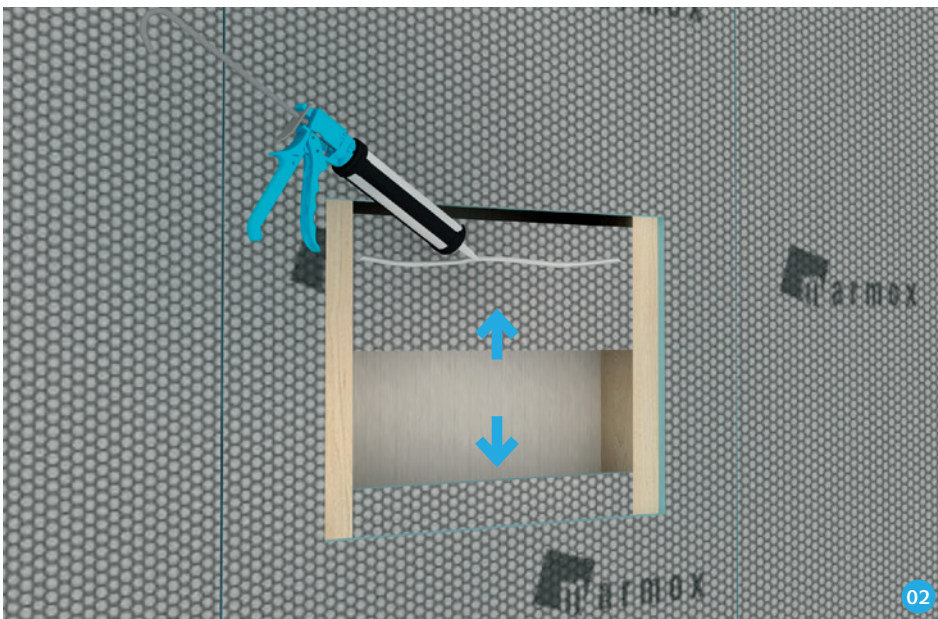

Work steps:

- 01 Cutting out the building board in the designated area. Thereby make sure that the stud frame partly for the gluing of the niche is free.
- 02 Adapting and gluing in a horizontal stop at the upper and lower edge of the cutout consisting of a MARMOX BOARD building board.
- 03 Adapting and gluing in a horizontal fence from the wood-stands on the upper and lower edge of the cutout.
- 04 Adapting and gluing in a horizontal stop of the metal-stands on the upper and lower edge of the cutout.

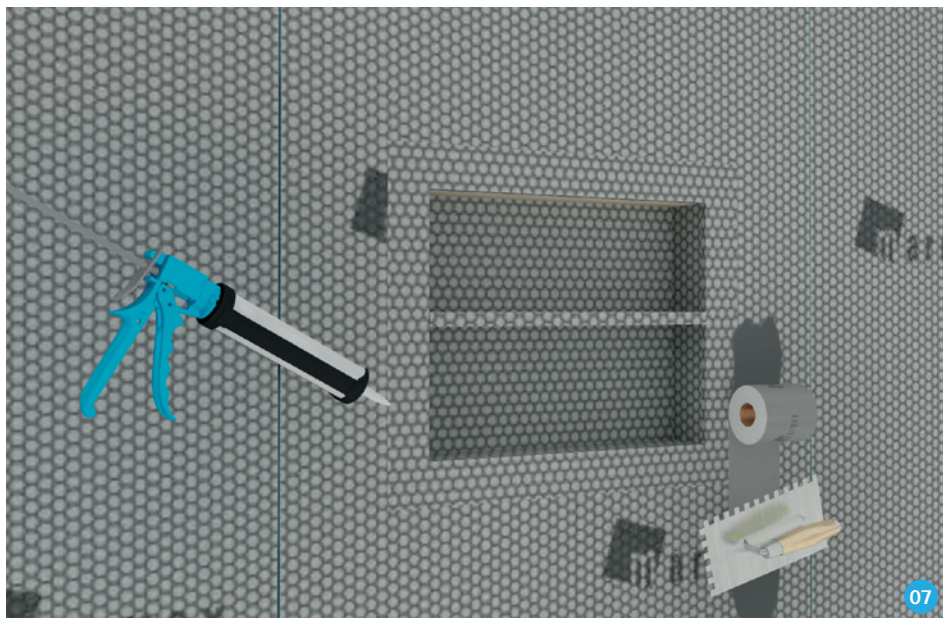
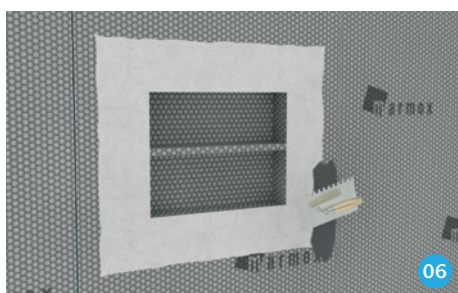
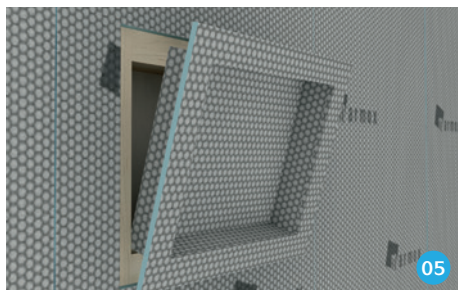

- 05 Fitting, 1-component polyurethane or MS-Apply polymer adhesive, the niche align and fix.
- 06 For niches with fleece: embedding the fleece all around with sealing slurries.
- 07 For niches without fleece: Gluing the joints and embedding of the waterproofing fleece with waterproofing slurry.
- 08 Tiling.

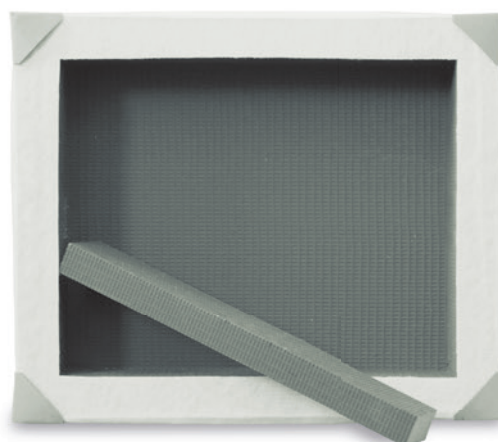

MARMOX niche 40/50 with waterproofing fleece and shelf



PRODUKTION

MARMOX Egypt S.A.E.
43 El Haram St.
Giza
Egypt

Tel.: +20 2 35 85 40 84
Fax: +20 2 35 85 98 58

E-Mail: info@marmoxegypt.com
www.marmoxboard.com

ANSCHRIFT

LMS -
Dr. Lietz Marketing Services GmbH
Wackenbergr. 65-75
D - 13156 Berlin

Tel.: +49 (0)30 47 75 03 50
Fax: +49 (0)30 47 71 14 1

E-Mail: lms@lms-berlin.de
www.marmox.de

